



# **Automatisierung**

**Betätiger**



**Endschalter**

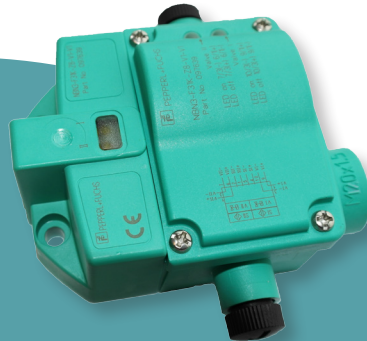

**Verschraubung**



**Pneumatik-Antrieb**

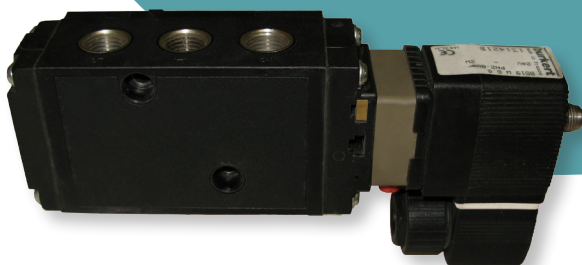

**Steuerventil**



**Ventilstecker**

**Betätiger**



**Endschalter**



**Verschraubung**



**Pneumatik-Antrieb**



**Steuerventil**

**Endschalter**



**Verschraubung**



**Pneumatik-Antrieb**



**Steuerventil**

**Betätiger**



**Endschalter**

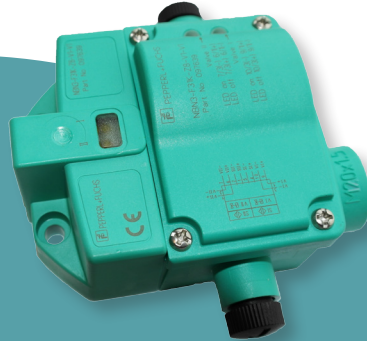

**Verschraubung**



**Pneumatik-Antrieb**



**Steuerventil**



**Ventilstecker**



**Betätiger**



**Endschalter**

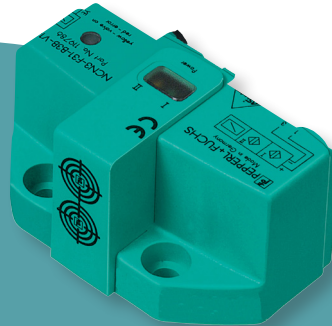

**Passivverteiler**



**Pneumatik-Antrieb**

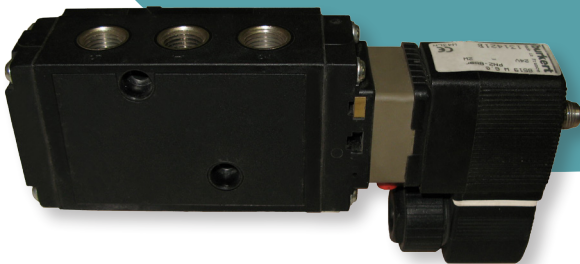

**Steuerventil**



**Ventilstecker**

**Schalldämpfer  
&  
Schmutzfänger**



10

11

12

13

**Entlüftungsrohr**



20

21

22

23

24

25

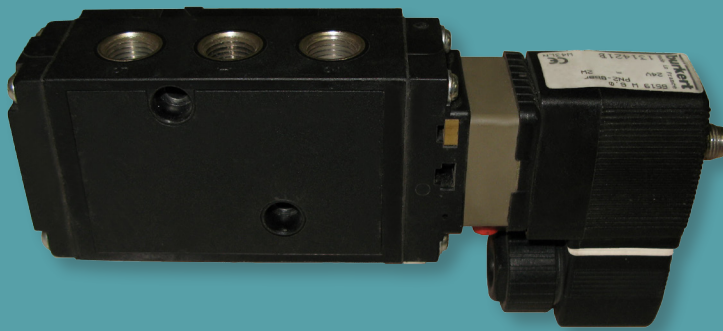

**Zwischendrosselplatte**

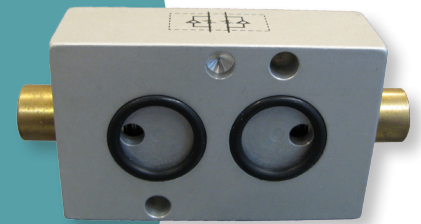

30

**Adaptors**

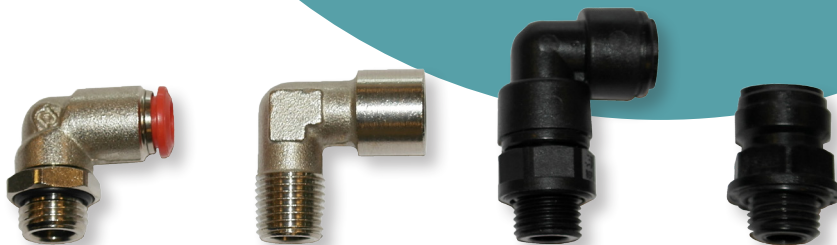

40

41

42

43

**Blindstopfen**



50



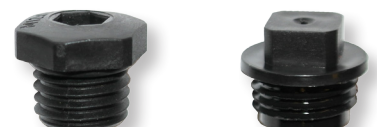

51



52

53

## SCHALLDÄMPFER & SCHMUTZFÄNGER

10		1/4": AF12021300 (Messing)	1/8": .....
11		1/4": AF12081306	1/8": .....
12		1/4": AF12061300	1/8": .....
13		1/4": .....	1/8": AF12021000 (Edelstahl)





## ENTLÜFTUNGSROHR

20		1/4": SODTUBE004	1/8": SODTUBE001
21		1/4": SODTUBE005	1/8": SODTUBE002
22		1/4": SODTUBE006	1/8": SODTUBE003
23		1/4": .....	1/8": .....
24		1/4": .....	1/8": .....
25		1/4": .....	1/8": .....

## ZWISCHENDROSSELPLATTE

30		ELOVPX	ELOVPXI (Edelstahl)
----	-------------------------------------------------------------------------------------	--------	------------------------

## ADAPTORS

41		1/4": AF13050813	1/8": .....
42		1/4": AF40101313	1/8": AF40101010
43		1/4": AF10010813 + AF10020800G	1/8": .....
44		1/4": AF10010813	1/8": .....

## BLINDSTOPFEN

50		1/4": .....	1/8": .....
51		1/4": AF40181301	1/8": AF40181001
52		1/4": .....	1/8": .....
53		1/4": .....	1/8": .....



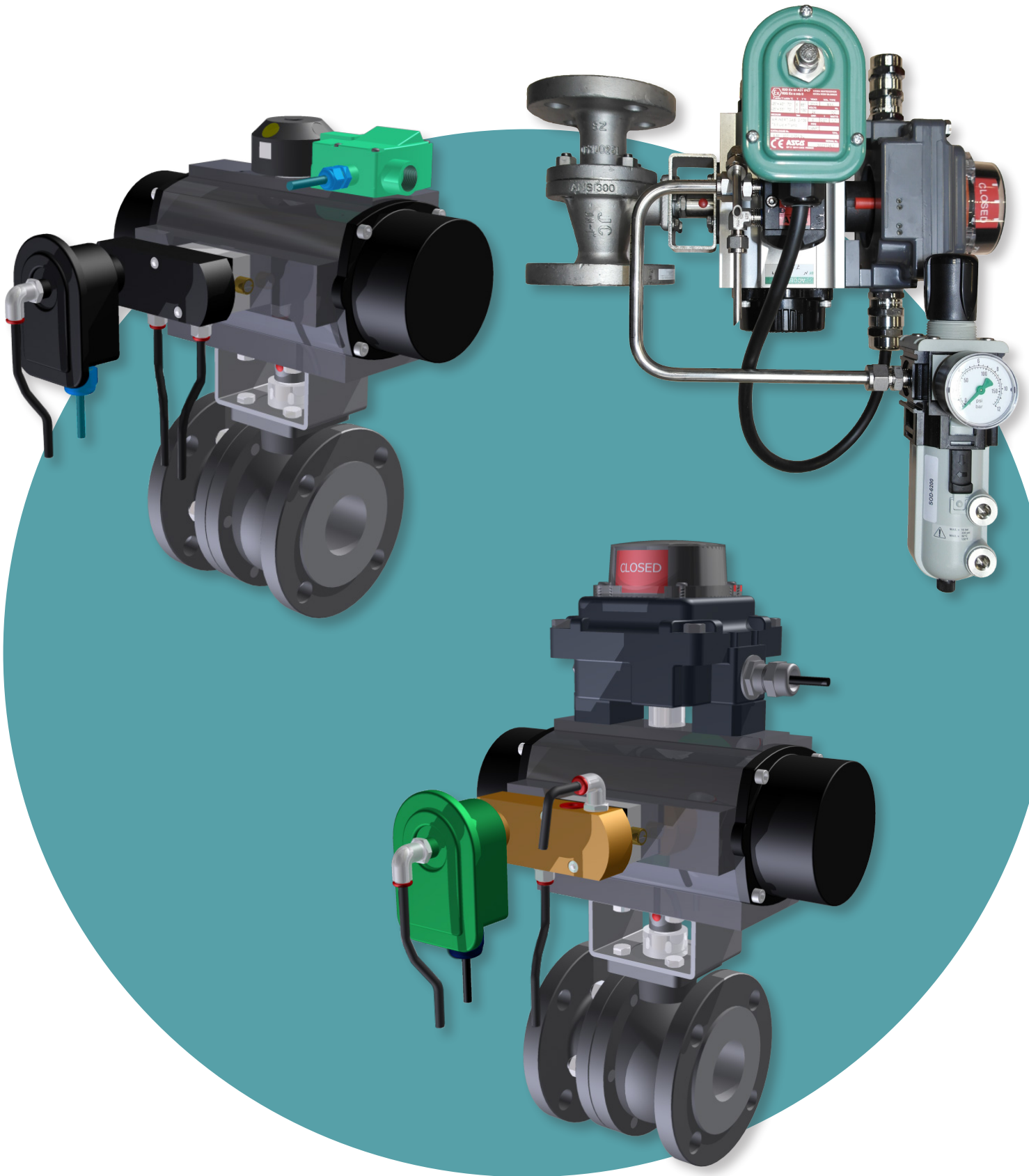

	ENDSCHALTER	VERSCHRAUBUNG	STEUERVENTIL	VENTILSTECKER
24 VDC	<b>2-Draht:</b> NBN3-F31K-Z8-V1-V1 (SD2166XX) <b>3-Draht:</b> NBN3-F31K-E8-V1-V1 (SD3166XX)	M20 x 1,5 CG (Grau, Kunststoff)	MNAM 24 VDC	<b>30 cm:</b> VMA-2+P/Z2-0,3M-PVC-V1-W-Y VC 12A <b>60 cm:</b> VMA-2+P/Z2-0,6M-PVC-V1-W-Y VC 12A
	<b>Optionen:</b> - Anzahl Anschlüsse für Steuerventile: 0, 1 oder 2 - andere Verschraubung - Zwischendrosselplatte Fig. ELOVPX			
3G3D	<b>2-Draht:</b> NBN3-F31K2M-Z8-B13-S-3G3D <b>3-Draht:</b> NBN3-F31K2M-E8-B13-S-3G3D	M20 x 1,5 CGEXE (schwarz, Kunststoff)	MNAMXC	
	<b>Optionen:</b> - 24 VDC: <b>2-Draht:</b> (NBN-F31K2-Z8-B13-S) oder <b>3-Draht:</b> (NBN-F31K2-E8-B13-S) - Eex i: NCN3-F31K2-N4-B13-S - ASI - Blindstopf (keine Durchverbindung) - Zwischendrosselplatte Fig. ELOVPX			
Eex d	TXP-M2CGNMM (SXM9XXT)	M20 x 1,5 CGEXD (Metal)	MNAMXC	-
	<b>Optionen:</b> - Anzahl Anschlüsse für Steuerventile: 0, 1 oder 2 - andere Verschraubung - Zwischendrosselplatte Fig. ELOVPX			
Eex i	NCN3-F31K-N4-V1-V1 (SDI166XX)	M20 x 1,5 CGEXI (Blau, Kunststoff)	MNAM I	V1S-W-N4-0,5M-PVC VC 12A EXi
	<b>Optionen:</b> - Anzahl Anschlüsse für Steuerventile: 0, 1 oder 2 - andere Verschraubung - Zwischendrosselplatte Fig. ELOVPX			
ASI	NCN3-F31-B3B-V1-V1 SDA66XX	VAZ-T1-FK-G10-V1 (neu)	MNAM 24 VDC	VMA-2+P/Z2- (neu) 0,3M-PVC-V1-W Endschalter nach Pilotventil